

# ISO 25498:2010

## Annulé le / Withdrawn on 2018-03-01

JUIN 2010

[www.afnor.org](http://www.afnor.org)

Ce document est à usage exclusif et non collectif des clients AFNOR.  
Toute mise en réseau, reproduction et rediffusion, sous quelque forme que ce soit, même partielle, sont strictement interdites.

This document is intended for the exclusive and non collective use of AFNOR customers.  
All network exploitation, reproduction and re-dissemination, even partial, whatever the form (hardcopy or other media), is strictly prohibited.

AFNOR

Pour : GN-MEBA

Client : 23432617

le : 12/04/2018 à 16:59

Diffusé avec l'autorisation de l'éditeur

Distributed under licence of the publisher



**DOCUMENT PROTÉGÉ  
PAR LE DROIT D'AUTEUR**

Droits de reproduction réservés. Sauf prescription différente, aucune partie de cette publication ne peut être reproduite ni utilisée sous quelque forme que ce soit et par aucun procédé, électronique ou mécanique, y compris la photocopie et les microfilms, sans accord formel.

Contacteur :  
AFNOR – Norm'Info  
11, rue Francis de Pressensé  
93571 La Plaine Saint-Denis Cedex  
Tél : 01 41 62 76 44  
Fax : 01 49 17 92 02  
E-mail : [norminfo@afnor.org](mailto:norminfo@afnor.org)

**afnor**



# INTERNATIONAL STANDARD

# ISO 25498

First edition  
2010-06-01

---

---

## **Microbeam analysis — Analytical electron microscopy — Selected-area electron diffraction analysis using a transmission electron microscope**

*Analyse par microfaisceaux — Microscopie électronique analytique —  
Analyse par diffraction par sélection d'aire au moyen d'un microscope  
électronique en transmission*



Reference number  
ISO 25498:2010(E)

© ISO 2010

## ISO 25498:2010(E)

### PDF disclaimer

This PDF file may contain embedded typefaces. In accordance with Adobe's licensing policy, this file may be printed or viewed but shall not be edited unless the typefaces which are embedded are licensed to and installed on the computer performing the editing. In downloading this file, parties accept therein the responsibility of not infringing Adobe's licensing policy. The ISO Central Secretariat accepts no liability in this area.

Adobe is a trademark of Adobe Systems Incorporated.

Details of the software products used to create this PDF file can be found in the General Info relative to the file; the PDF-creation parameters were optimized for printing. Every care has been taken to ensure that the file is suitable for use by ISO member bodies. In the unlikely event that a problem relating to it is found, please inform the Central Secretariat at the address given below.



### COPYRIGHT PROTECTED DOCUMENT

© ISO 2010

All rights reserved. Unless otherwise specified, no part of this publication may be reproduced or utilized in any form or by any means, electronic or mechanical, including photocopying and microfilm, without permission in writing from either ISO at the address below or ISO's member body in the country of the requester.

ISO copyright office  
Case postale 56 • CH-1211 Geneva 20  
Tel. + 41 22 749 01 11  
Fax + 41 22 749 09 47  
E-mail [copyright@iso.org](mailto:copyright@iso.org)  
Web [www.iso.org](http://www.iso.org)

Published in Switzerland

## Contents

Page

Foreword .....	iv
Introduction.....	v
1 Scope .....	1
2 Normative references .....	1
3 Terms, definitions and symbols .....	1
4 Principle.....	2
4.1 Spot diffraction pattern.....	2
4.2 Kikuchi pattern .....	5
4.3 Polycrystalline specimen.....	6
5 Equipment .....	7
6 Specimens.....	7
7 Reference materials .....	7
8 Experimental procedure .....	8
8.1 Instrument preparation .....	8
8.2 Procedure for acquirement of selected-area electron diffraction patterns .....	8
8.3 Determination of diffraction constant $L\lambda$ .....	10
9 Measurement and solution of the SAED patterns.....	11
9.1 Selection of the basic parallelogram.....	11
9.2 Indexing diffraction spots.....	12
10 The 180° ambiguity .....	13
11 Uncertainty estimation.....	13
11.1 Factors affecting accuracy .....	13
11.2 Calibration with a reference material .....	14
Annex A (informative) Interplanar spacing of pure Au and Al .....	15
Annex B (informative) Spot diffraction patterns of single crystals with body-centred cubic (BCC, face-centred cubic (FCC) and hexagonal close packed (HCP) structure .....	16
Bibliography.....	28

## ISO 25498:2010(E)

### Foreword

ISO (the International Organization for Standardization) is a worldwide federation of national standards bodies (ISO member bodies). The work of preparing International Standards is normally carried out through ISO technical committees. Each member body interested in a subject for which a technical committee has been established has the right to be represented on that committee. International organizations, governmental and non-governmental, in liaison with ISO, also take part in the work. ISO collaborates closely with the International Electrotechnical Commission (IEC) on all matters of electrotechnical standardization.

International Standards are drafted in accordance with the rules given in the ISO/IEC Directives, Part 2.

The main task of technical committees is to prepare International Standards. Draft International Standards adopted by the technical committees are circulated to the member bodies for voting. Publication as an International Standard requires approval by at least 75 % of the member bodies casting a vote.

Attention is drawn to the possibility that some of the elements of this document may be the subject of patent rights. ISO shall not be held responsible for identifying any or all such patent rights.

ISO 25498 was prepared by Technical Committee ISO/TC 202, *Microbeam analysis*, Subcommittee SC 3, *Analytical electron microscopy*.

## Introduction

Electron diffraction techniques are widely used in transmission electron microscopy (TEM) studies. Applications include phase identification, determination of the crystalline lattice type and lattice parameters, crystal orientation and the orientation relationship between two phases, phase transformations, habit planes and defects, twins and interfaces, as well as studies of preferred crystal orientations (texture) etc. While several complementary techniques have been developed, e.g. microdiffraction, convergent beam diffraction and reflected diffraction, selected-area electron diffraction (SAED) is the most frequently employed. Selected-area electron diffraction allows direct analysis of small areas of the sample (fine layers, grains, precipitates, etc.) and is routinely performed on thin specimens of a variety of crystalline materials. The SAED is also a supplementary technique for acquisition of high resolution images, microdiffraction or convergent beam diffraction studies. The information generated is widely used in the studies of structure/property relationships as well as for inspection and quality control purposes.

This International Standard explains the mechanism of the diffraction pattern formation, the practical aspects of SAED operation and the indexing of the patterns.



# Microbeam analysis — Analytical electron microscopy — Selected-area electron diffraction analysis using a transmission electron microscope

## 1 Scope

This International Standard specifies the method of selected-area electron diffraction (SAED) analysis using a transmission electron microscope (TEM) to analyse micrometer and sub-micrometer sized areas of thin crystalline specimens. Such specimens can be obtained in the form of thin sections from a variety of metallic and non-metallic materials, as well as fine powders, or alternatively by the use of extraction replicas. The minimum diameter of the selected area in a specimen which can be analysed by this method depends on the spherical aberration coefficient of the objective lens of the microscope and approaches 0,5  $\mu\text{m}$  for a modern TEM.

When the diameter of an analysed specimen area is smaller than 0,5  $\mu\text{m}$ , the analysis procedure can also be referred to this International Standard but, because of the effect of spherical aberration, some of the diffraction information in the pattern can be generated from outside of the area defined by the selected-area aperture. In such cases, the use of microdiffraction or convergent beam electron diffraction, where available, might be preferred.

The success of the selected-area electron diffraction method relies on the validity of indexing the diffraction patterns arising, irrespective of which axis in the specimen lies parallel to the incident electron beam. Such analysis is therefore aided by specimen tilt and rotation facilities.

This International Standard is applicable to acquisition of SAED patterns from crystalline specimens, indexing the patterns and calibration of the diffraction constant.

## 2 Normative references

The following referenced documents are indispensable for the application of this document. For dated references, only the edition cited applies. For undated references, the latest edition of the referenced document (including any amendments) applies.

ISO/IEC 17025, *General requirements for the competence of testing and calibration laboratories*

## 3 Terms, definitions and symbols

For the purposes of this document, the following terms and definitions apply.

### 3.1

$(hkl)$

Miller indices of a specific set of crystalline planes

### 3.2

$\{hkl\}$

Miller indices, which denote a family of crystalline planes

## ISO 25498:2010(E)

### 3.3

$[uvw]$

Miller indices of a specific crystalline direction or a zone axis

### 3.4

$(uvw)$

Miller indices, which denote a family of crystalline directions

### 3.5

**interplanar spacing**

$d_{hkl}$

perpendicular distance between consecutive planes of the crystalline plane set  $(hkl)$

### 3.6

$(uvw)^*$

indices of a plane in the reciprocal lattice

NOTE The normal of the reciprocal plane  $(uvw)^*$  is parallel to the crystalline zone axis  $[uvw]$ .

### 3.7

**reciprocal vector**

$g_{hkl}$

vector in the reciprocal lattice

NOTE The reciprocal vector  $g_{hkl}$  is normal to the crystalline plane  $(hkl)$  with its magnitude inversely proportional to interplanar spacing  $d_{hkl}$ .

### 3.8

$R_{hkl}$

vector from centre 000 (the origin) to the diffraction spot  $hkl$  in a diffraction pattern

See Figure 1.

### 3.9

**eucentric position**

specimen position at which the image exhibits minimal lateral motion resulting from specimen tilting

## 4 Principle

When an energetic electron beam is incident upon a thin crystalline specimen in a transmission electron microscope, a diffraction pattern will be produced in the back focal plane of the objective lens. This pattern is magnified by the intermediate and projector lenses, and displayed on a viewing screen. This pattern can also be displayed on a monitor if the TEM is equipped with a TV or charge-coupled device (CCD) camera system.

### 4.1 Spot diffraction pattern

The diffraction pattern of a single crystal appears as an array of 'spots', the basic unit of which is characterized by a parallelogram. A schematic illustration of a spot diffraction pattern is shown in Figure 1. Each spot corresponds to diffraction from a specific set of crystal lattice planes in the specimen, denoted by Miller indices  $(hkl)$ . The vector  $R_{hkl}$  is defined by the position of the diffracted spot  $hkl$  relative to position on the pattern corresponding to the transmitted beam, i.e. the centre-spot 000 of the pattern. It is parallel to the normal of the reflecting plane  $(hkl)$ . The magnitude of  $R_{hkl}$  is inversely proportional to the interplanar spacing  $d_{hkl}$  of the diffracting plane  $(hkl)$  (References [1], [2], [3] and [4] in the Bibliography). In the context of this International Standard, vectors  $R_{h_1k_1l_1}$ ,  $R_{h_2k_2l_2}$ ,  $(R_{h_2k_2l_2} - R_{h_1k_1l_1})$  and  $(R_{h_1k_1l_1} + R_{h_2k_2l_2})$  are simplified as  $R_1$ ,  $R_2$ ,  $R_{2-1}$  and  $R_{1+2}$ , respectively. The included angle between vectors  $R_1$  and  $R_2$  is denoted by  $\gamma^*$ .

Because the centre-spot is often very bright, it is often difficult to determine the exact centre of the pattern. Therefore, a practical procedure is to establish the magnitude of  $|R_{hkl}|$  by measuring the distance between the spots  $hkl$  and  $\bar{h}\bar{k}\bar{l}$  on the diffraction pattern and dividing by two, i.e.  $|R_{hkl}| = \frac{1}{2}(|R_{hkl}| + |R_{\bar{h}\bar{k}\bar{l}}|)$ . Figure 2 shows an example of the SAED pattern where the magnitude of  $R_1$ ,  $R_2$  and  $R_{2-1}$  is obtained from  $\frac{1}{2}(R_1 + \bar{R}_1)$ ,  $\frac{1}{2}(R_2 + \bar{R}_2)$  and  $\frac{1}{2}(R_{2-1} + \bar{R}_{2-1})$ , respectively.

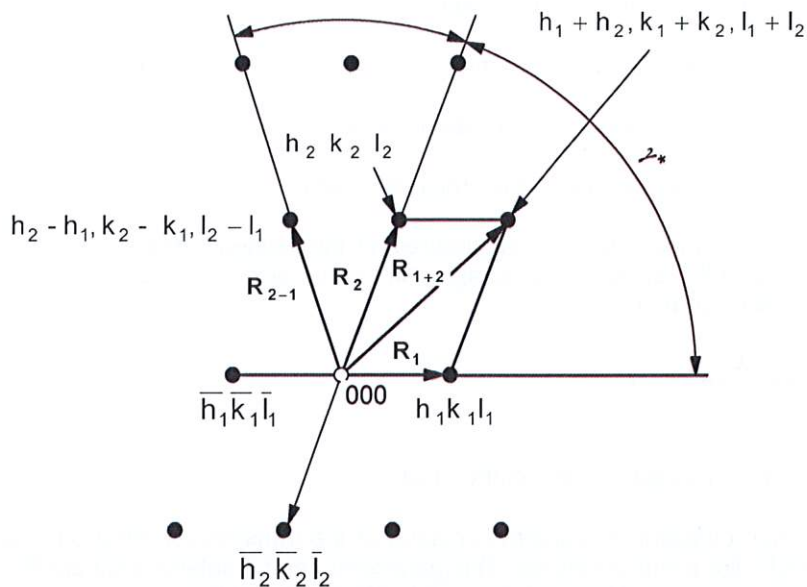

Figure 1 — Schematic spot diffraction pattern from a single crystal, the basic parallelogram constituted by the diffraction spots  $h_1k_1l_1$ ,  $h_2k_2l_2$ ,  $(h_1 + h_2, k_1 + k_2, l_1 + l_2)$  and central spot 000

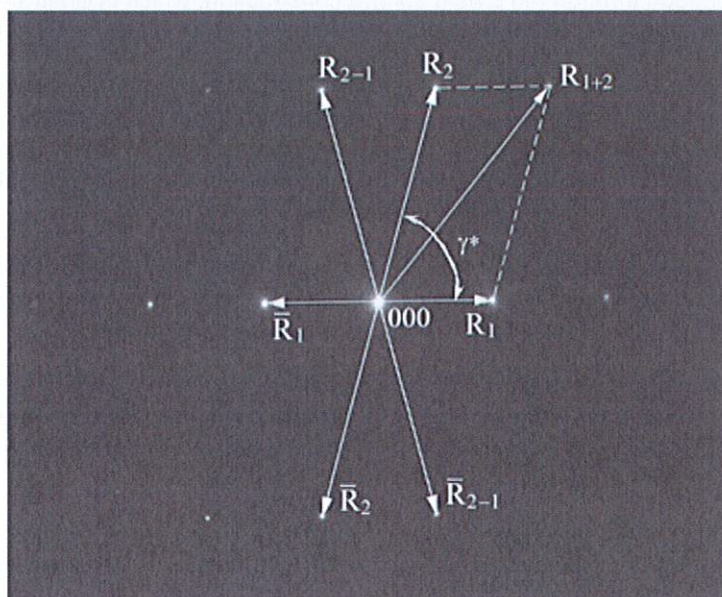

Figure 2 — Example of SAED spot pattern showing the basic parallelogram constituted by  $R_1$  and  $R_2$

## ISO 25498:2010(E)

The relationship between the interplanar spacing  $d_{hkl}$  and the magnitude  $R_{hkl}$  for a reflecting plane  $(hkl)$  can be approximately expressed as (Reference [4] in the Bibliography)

$$L\lambda = R_{hkl} \times d_{hkl} \left[ 1 - \frac{3}{8} \times \left( \frac{R_{hkl}}{L} \right)^2 \right] = R_{hkl} \times d_{hkl} (1 - \Delta) \quad (1)$$

where

$L = f_o \times M_i \times M_p$  is the diffraction camera length,

$f_o$  is the focal length, in millimetres, of the objective lens in the microscope,

$M_i$  is the magnification of the intermediate lens,

$M_p$  is the magnification of the projector lenses,

$\lambda$  is the wavelength, in nanometres, of the incident electron beam which is dependent upon the accelerating voltage and can be given by Equation (2) (Reference [2] in the Bibliography):

$$\lambda(\text{nm}) = \frac{1,226}{\sqrt{V(1 + 0,978 \times 10^{-6} V)}} \quad (2)$$

where  $V$  is the accelerating voltage, in volts, of the TEM,

$L\lambda$  is the diffraction constant (or camera constant) of the transmission electron microscope operating under the particular set of conditions. This parameter can be determined from the diffraction pattern of a crystalline specimen of known lattice parameters (refer to 8.3).

For most work using a TEM, the value of  $\Delta$  in Equation (1) is usually smaller than 0,1 % and hence a more simplified equation may be used, namely

$$R_{hkl} \times d_{hkl} = L\lambda \quad (3)$$

This relation can be understood through the Ewald sphere construction, which is illustrated in Figure 3. For the derivation of the above equation, refer to the textbooks (References [2] to [6] in the Bibliography).

The use of Equation (3) requires measuring the length of  $R_{hkl}$ . Since, as mentioned earlier, the location of the pattern centre may not be easily determined, it is recommended that the distance measurement taken,  $2 R_{h_1 k_1 l_1}$ , be from the  $h_1 k_1 l_1$  diffracted spot to the  $\bar{h}_1 \bar{k}_1 \bar{l}_1$  spot on the pattern. This is equivalent to a diameter measurement on the ring pattern from a polycrystalline specimen. To obtain the interplanar information, the measured distance  $2 R_{h_1 k_1 l_1}$  is halved and Equation (3) applied.

If the camera constant is known, the interplanar spacing  $d_{hkl}$  of plane  $(hkl)$  can be calculated. The included angle between any two vectors  $R_{h_1 k_1 l_1}$  and  $R_{h_2 k_2 l_2}$  can also be measured on the diffraction pattern. This is equal to the angle between the corresponding crystalline planes  $(h_1 k_1 l_1)$  and  $(h_2 k_2 l_2)$ .

Since diffraction data from a single pattern will provide information on a limited number of the possible diffracting planes in a specimen area, it is necessary to acquire additional diffraction patterns from the same area (or from different grains/particles of the same phase). This requires either the tilting of the specimen or the availability of differently oriented grains or particles of the same phase.

Acquire a second diffraction pattern from another zone axis from the same area by tilting the specimen so that the two patterns contain a common spot row (also see 8.2.10). Index the diffracted spots, and then select three non-planar spots in the two patterns to constitute a reciprocal lattice, which, if the spots correspond to low values of Miller indices, may define the primitive unit cell of the crystal lattice. Therefore, crystal lattice parameters can be determined and the orientation of the grain or particle in the thin specimen can also be calculated.

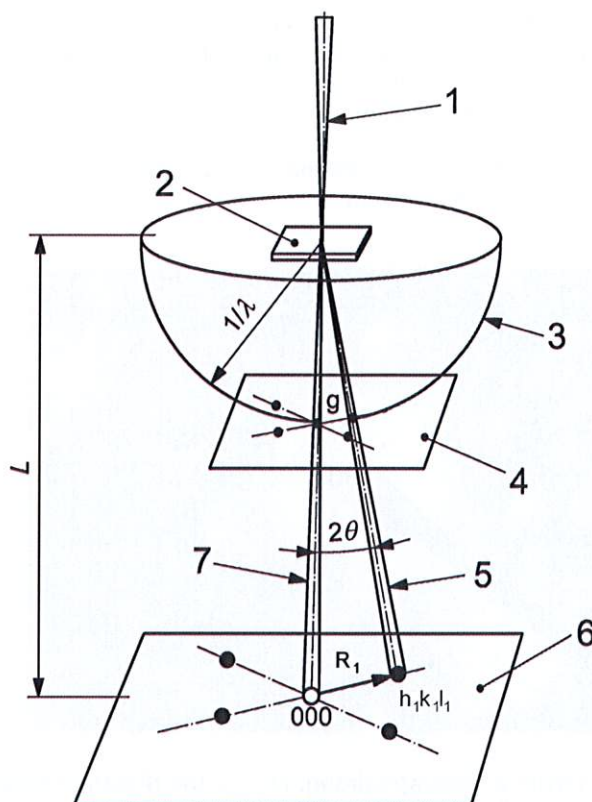

**Key**

- 1 incident beam
- 2 specimen
- 3 Ewald sphere
- 4 reciprocal plane
- 5 diffracted beam
- 6 diffraction pattern
- 7 transmitted beam

Figure 3 — Ewald sphere construction illustrating the diffraction geometry in TEM

**4.2 Kikuchi pattern**

When a specimen area is nearly perfect but not thin enough, Kikuchi lines may occur. They arise from electrons scattered inelastically through a small angle and suffering only a very small energy loss being scattered again this time elastically. This process leads to local variations of the background intensity in the diffraction pattern and the appearance of Kikuchi lines.

The Kikuchi patterns consist of pairs of parallel bright and dark lines, which are parallel to the projection of the corresponding reflecting planes. The bright (excess) line and dark (defect) line in the Kikuchi pattern are denoted by  $K_{B-hkl}$  and  $K_{D-hkl}$ , respectively. Therefore, the line pair,  $K_{B-hkl}$  and  $K_{D-hkl}$ , will be perpendicular to the vector  $R_{hkl}$  from the corresponding crystalline plane ( $hkl$ ). An example of a Kikuchi pattern is given in Figure 4, where the bright line  $K_{B-hkl}$  and dark line  $K_{D-hkl}$  pair is superimposed on the spot pattern. The perpendicular distance  $D_{K-hkl}$  between the line pair,  $K_{B-hkl}$  and  $K_{D-hkl}$ , is related to the interplanar spacing  $d_{hkl}$  and camera constant  $L\lambda$  by Equation (4).

$$D_{K-hkl} \times d_{hkl} = L\lambda \tag{4}$$

ISO 25498:2010(E)

The angles between different Kikuchi line pairs are also equal to the angles between the relevant crystalline planes. The Kikuchi patterns present the real crystal symmetry of the specimen. They are a very useful aid in tilting the specimen from one zone axis to another and also in establishing crystal orientation with very high accuracy (References [6] and [7] in the Bibliography).

Generally, when Kikuchi lines are visible, the specimen-tilting method is preferred to acquire diffraction patterns with different zone axes from the same area.

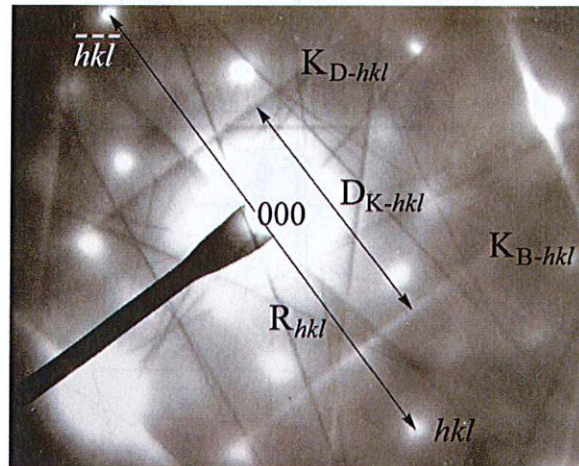

Figure 4 — Kikuchi pattern from a steel specimen,  $D_{K-hkl}$ : the distance between the line pair  $K_{B-hkl}$  (bright line) and  $K_{D-hkl}$  (dark line)

4.3 Polycrystalline specimen

The diffraction pattern from a polycrystalline specimen is comprised of a series of concentric rings centred on the transmitted spot 000. An example of the pattern from a polycrystalline gold (Au) specimen is given in Figure 5. Each diffracted ring arises from the diffraction beams from differently oriented crystalline planes of the form  $\{hkl\}$ ; each of these having an identical interplanar spacing. From the diameter of each diffraction ring, the corresponding interplanar spacing  $d_{hkl}$  can be calculated using Equation (3). Indices of the diffraction rings can be ascribed and then the lattice parameters can also be determined. For the method of indexing ring patterns refer to that used in X-ray powder diffraction (Reference [8] in the Bibliography).

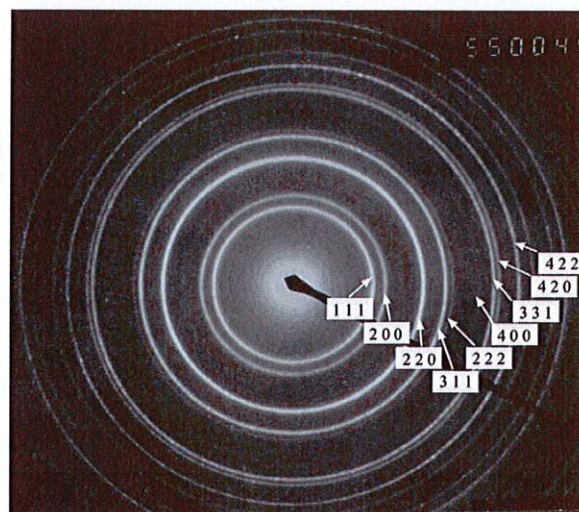

Figure 5 — Diffraction ring pattern with indices from a polycrystalline Au specimen

## 5 Equipment

- 5.1 **Transmission electron microscope**, with double tilt or tilt rotation specimen holder.
- 5.2 For a TEM not equipped with a TV or CCD camera system, **films or imaging plates** are necessary for recording the patterns. When films are used, the following facilities are also required.
- 5.2.1 **Measuring magnifier and protractor**, to measure length and plane angle, respectively.
- 5.2.2 **Photographic materials and negative viewer**.
- 5.2.3 **Darkroom**, with negative developing and fixing outfit.
- 5.3 **Facilities for specimen preparation**.

## 6 Specimens

- 6.1 Most specimens are prepared as thin foils (References [9] and [10] in the Bibliography). The shape and external size of the specimen should match that of the TEM specimen holder or alternatively it can be held by a support grid. Extraction replicas or powdered specimens shall be prepared on the grid with supporting films.
- 6.2 The selected specimen area shall be thin enough for the electron beam to pass through it and diffraction patterns can be observed on the viewing screen.
- 6.3 The surface of the specimen shall be clean, dry and flat without an oxidizing layer or any contamination.
- 6.4 For those materials that are stable under energetic particle beam bombardment, contamination on the specimen surface can be avoided or removed by ion beam sputtering or other techniques before the TEM observation (Reference [10] in the Bibliography).
- 6.5 Prepared specimens shall be labelled and placed in a special specimen box and preserved in a desiccator or evacuated container.

## 7 Reference materials

A reference specimen is required for determining the diffraction constant  $L\lambda$  of the microscope in electron diffraction studies. In principle, any thin crystalline foil or powder could be considered as the reference specimen, provided its crystalline structure and lattice parameters have been acquired accurately and they are certified and stable under irradiation of the electron beam. The thickness of the crystal foil or powder grain size should be consistent with the beam energy and the quality of the diffraction pattern (when it is too thick the pattern will lack sharpness).

Reference materials in common use are polycrystalline specimens made from pure gold (which has a face-centred cubic (fcc) lattice with parameter  $a = 0,407\ 8\ \text{nm}$ ) or pure aluminium (Al) (fcc structure with lattice parameter  $a = 0,404\ 9\ \text{nm}$ ). The mass fraction of Au or Al in the reference materials shall be not less than 99,9 %. The reference specimen shall be prepared by evaporating a small piece of Au or Al on a grid with a supporting film.

It is also feasible to evaporate a layer of the reference material onto a local surface area of the specimen, which is to be analysed.

## ISO 25498:2010(E)

### 8 Experimental procedure

#### 8.1 Instrument preparation

- 8.1.1 The general working condition of the TEM laboratory shall comply with ISO/IEC 17025.
- 8.1.2 It is recommended to use the cold finger of TEM before conditioning in order to minimize specimen contamination.
- 8.1.3 When the vacuum of the transmission electron microscope is suitable for operation, switch on and select an appropriate accelerating voltage.
- 8.1.4 Carry out the axis alignment for the electron optical system.
- 8.1.5 Place the specimen to be observed and the reference firmly in the double-tilting or tilting-rotation specimen holder, and insert the holder into the specimen chamber.

A specimen coated with an evaporated layer of reference material can be directly placed in the specimen holder and inserted into the chamber.

- 8.1.6 When the SAED patterns need to be related to features observed in the corresponding micrograph the angle of rotation between the two may need to be determined and compensated for.

The method in common use is to take a diffraction pattern and a micrograph of a molybdenum trioxide crystal specimen. The rotation angle of the image is then measured on the photographic plates, on which the micrograph and superimposed diffraction pattern has been recorded. For details of the calibration procedure refer to the appropriate text books (References [2][5][7] in the Bibliography).

#### 8.2 Procedure for acquirement of selected-area electron diffraction patterns

- 8.2.1 Obtain a magnified bright field image of the specimen on the viewing screen of the transmission electron microscope. Adjust the specimen height to the eucentric position so that the image movement is minimized during tilting of the specimen. The procedure for establishing the eucentric position of the specimen may be obtained by consulting the manufacturer's operating manual.
- 8.2.2 Adjust the magnification of the specimen image until details in the specimen can be observed clearly. A suitable magnification for SAED analysis is usually from about 5,000 to 50,000 times. Focus the image and correct the astigmatism.
- 8.2.3 Insert the field limiting aperture (selected-area aperture) and focus the image of this aperture. Focus the specimen image again. This makes the selected-area aperture plane conjugate with the image plane of the objective lens.
- 8.2.4 Switch the microscope to the diffraction mode, focus the image of the objective lens aperture, that is, make this objective lens aperture coincide with the back focal plane of the objective lens. Return to the bright field image mode and focus the image again.
- 8.2.5 Insert the reference (i.e. the calibration standard) and locate at the eucentric position. Choose a camera length  $L$  consistent with the capabilities of the subsequent measuring equipments and then obtain a diffraction pattern from it. Focus the diffraction pattern and correct any astigmatism carefully to make the diffraction pattern sharp. Record the diffraction pattern of the reference.
- 8.2.6 If the reference and test specimen are not in the same specimen holder, withdraw the reference and insert the test specimen again, without changing the operating conditions and without switching the microscope off. Again locate it at the eucentric height.
- 8.2.7 Obtain a focused bright field image of the specimen again with an appropriate magnification.

Select an area of interest on the specimen using the field limiting aperture (selected-area aperture). Record the image of the specimen area. The phase boundary and grain boundaries in the specimen should be kept away from the selected area when a single crystal grain is analysed.

**8.2.8** Switch to the diffraction mode again, withdraw the objective lens aperture and obtain a diffraction pattern on the viewing screen. Where possible, tilt the specimen slightly so that brightness of the spots in the diffraction pattern is evenly distributed, or where Kikuchi lines appear; the Kikuchi line pairs are symmetrical about the pattern centre.

This pattern will then derive from a small index direction in the crystal approximately parallel to the incident electron beam. This crystal direction will be the zone axis  $[u_1v_1w_1]$ , which is the normal of the reciprocal plane  $(u_1v_1w_1)^*$ , i.e. the diffraction pattern (References [3] and [4] in the Bibliography).

Adjust (defocus) the second condenser lens current (the brightness knob) to sharpen the diffraction spots, making them as sharp as possible.

**8.2.9** Record the pattern or/and save the original uncompressed pattern in the computer system. Take note of the reading on the  $X$  and  $Y$  axis of the specimen-tilting device as  $X_1$  and  $Y_1$ , respectively. Using dark field conditions, identify the source of the pattern.

**8.2.10** Insert the reference specimen and obtain a second diffraction pattern from the reference. Record this diffraction pattern (also see 8.3), making sure that the same experimental conditions are used (i.e. accelerating voltage, lens settings and, especially, the specimen height and camera length  $L$ ).

**8.2.11** Obtain sufficient data for each phase of interest by either of the following procedures.

a) By tilting the specimen. Choose a row of close-spaced diffraction spots collinear with the central transmitted spot on the diffraction pattern. Align this row with the tilting axis and obtain the second diffraction pattern  $(u_2v_2w_2)^*$  and additional ones where possible. Repeat the procedure described in 8.2.8, recording the spot pattern and/or saving it on the computer system. Take note of the reading on the  $X$  and  $Y$  axis of the specimen-tilting device as  $X_2$  and  $Y_2$ , respectively.

The angle  $\psi$  between the diffraction pattern  $(u_1v_1w_1)^*$  and  $(u_2v_2w_2)^*$ , is the angle between the two zone axes  $[u_1v_1w_1]$  and  $[u_2v_2w_2]$ , and can be determined from the tilt angle of the specimen holder. The reciprocal space geometry of the patterns is illustrated in Figure 6.

b) When any of the following situations occur.

- 1) The maximum tilting angle of the specimen holder is not large enough, so that the second diffraction pattern cannot be reached by tilting.
- 2) The particles to be analysed in the specimen are too small.
- 3) The specimen is sensitive to the electron beam illumination: e.g. the selective area is contaminated or decomposes following short irradiation by the electron beam.

Obtain and record patterns from several areas, i.e. different particles or grains of the same phase. Choose appropriate diffraction spots to form a dark field image to confirm the source of each diffraction pattern. Further confirmation can be achieved through simultaneous use of an EDX (energy dispersive X-ray spectrometry) facility, when available.

ISO 25498:2010(E)

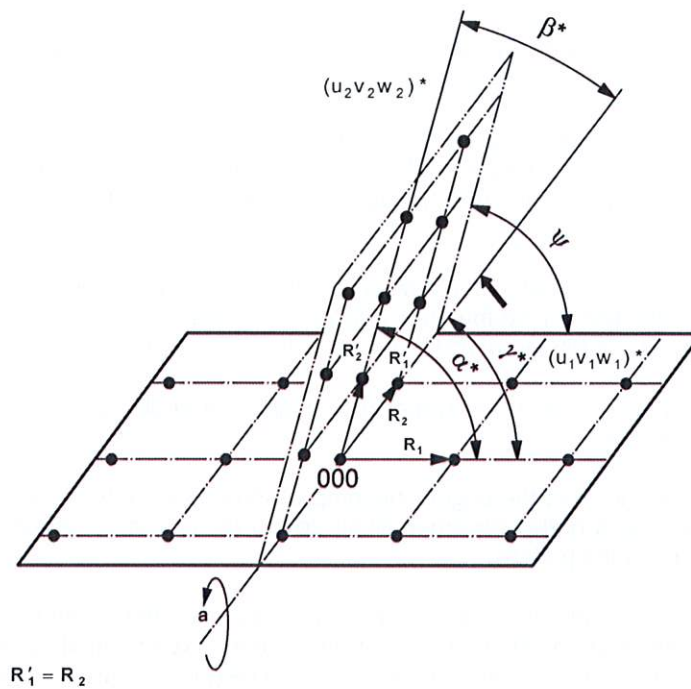

$R_1 = R_2$

<sup>a</sup> Tilting axis.

Figure 6 — Reciprocal space geometry of the spot diffraction patterns

8.2.12 When the diffraction patterns are recorded on negative films, develop, fix and dry the films in the darkroom. Keep the negative films one by one in an individual protective bag with label.

8.2.13 When the diffraction patterns are recorded by TV or CCD camera or imaging plates, save the original uncompressed diffraction patterns in the computer system as an individual file with label. All parameters of the acquisition of this file shall be documented and reported.

8.2.14 Each pattern, either recorded on negative film or by TV, CCD camera as well as by imaging plate, shall be numbered and labelled with the following information: specimen designation and serial number, accelerating voltage, nominal camera length  $L_n$ , tilting angles, operator, date, etc. All processing operations of the diffraction patterns and images shall be reported.

8.3 Determination of diffraction constant  $L\lambda$

8.3.1 The procedure for determination of diffraction constant uses a reference specimen such as polycrystalline pure gold or pure aluminium (see Clause 7). Figure 5 shows an example of the ring patterns from a polycrystalline gold specimen. Record the diffraction pattern, see 8.2.

8.3.2 When diffraction patterns are recorded on negative films, place the negative film on which the diffraction pattern of the reference specimen was recorded, emulsion side up on the film viewer. Measure the diameters of the diffraction rings on the film of the reference specimen when polycrystalline reference is used. Note the diameter of these rings from inner to outer as  $D_1, D_2, D_3, D_4, \dots$  (mm) etc. respectively.

8.3.3 Indices  $hkl$  of the diffraction rings for a reference specimen with fcc structure are 111, 200, 220, 311, 222, 400, 331, 420, 422, ... respectively from inner to outer rings (see Figure 5). The corresponding interplanar spacing  $d_{hkl}$  is given for both Au and Al in Annex A or calculated by the crystallographic formulae (Reference [4] in the Bibliography).

8.3.4 Calculate the diffraction constants as follows:

$$2L_1\lambda = D_1 \times d_{111} \text{ (mm}\cdot\text{nm)}$$

$$2L_2\lambda = D_2 \times d_{200} \text{ (mm}\cdot\text{nm)}$$

$$2L_3\lambda = D_3 \times d_{220} \text{ (mm}\cdot\text{nm)} \dots \text{ etc.}$$

8.3.5 Plot the  $2L\lambda - D$  curve (or  $L\lambda - D/2$  curve) using the data in 8.3.2 and 8.3.4 (an example of the  $L\lambda - D/2$  plot is shown in Figure 7). This graph could be used for all reflections (spots) from the specimen being analysed under completely identical conditions. Since the diffraction constant  $L\lambda$  actually varies slightly with the diffraction ring diameter, it is recommended either

- a) to use the  $L\lambda - D/2$  curve to obtain the value of  $L\lambda$  corresponding to the same distance,  $D/2$ , as the spot being measured, or
- b) to use an average value of the camera constant and subsequently make allowance for the small uncertainty this will produce in the  $d$ -value obtained.

8.3.6 When the diffraction patterns are recorded by TV or CCD camera, the above measurements and calculations can be carried out by the computer system.

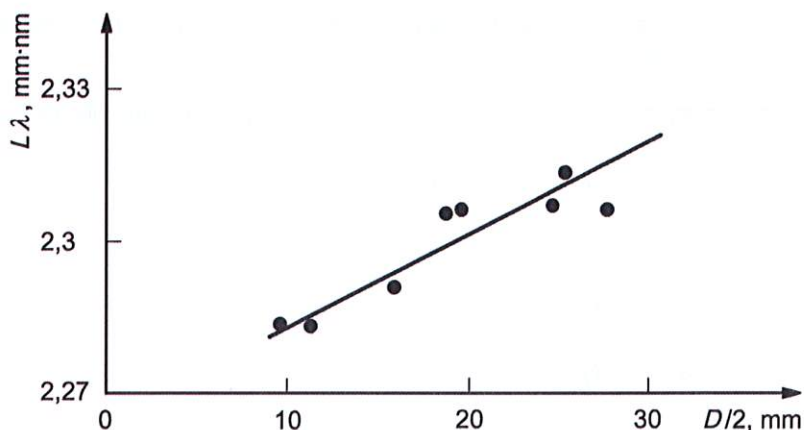

Figure 7 —  $L\lambda - D/2$  curve from a polycrystalline Au specimen

## 9 Measurement and solution of the SAED patterns

### 9.1 Selection of the basic parallelogram

9.1.1 When films are used for recording diffraction patterns, place the film, on which the diffraction pattern was recorded, on the film viewer with its emulsion side up.

9.1.2 Select two diffracted spots  $h_1k_1l_1$  and  $h_2k_2l_2$  from the diffraction pattern with zone axis  $[u_1v_1w_1]$  such that these spots are nearest and next nearest to the central spot 000, respectively. They shall not be collinear with the centre-spot 000. The two diffracted spots, the centre-spot and the spot  $(h_1 + h_2, k_1 + k_2, l_1 + l_2)$  constitute a parallelogram (see Figure 1).

Measure the distance  $2R_1$  between the spots  $h_1k_1l_1$  and  $\bar{h}_1\bar{k}_1\bar{l}_1$ , and the distance  $2R_2$  between the spots  $h_2k_2l_2$  and  $\bar{h}_2\bar{k}_2\bar{l}_2$ , to get the magnitude of the vectors  $R_1$  and  $R_2$  (see Figures 1 and 2). The corresponding angle  $\gamma^*$  between  $R_1$  and  $R_2$  shall also be measured.

## ISO 25498:2010(E)

Where individual patterns are obtained, obtain the magnitude of the vectors  $R_{1+2}$  and  $R_{2-1}$  (see Figures 1 and 2). The angles between  $\bar{R}_1$  and  $R_{2-1}$ , between  $R_{2-1}$  and  $R_2$  and the angle between  $\bar{R}_1$  and  $R_2$  shall be measured. These are  $\phi_3$ ,  $\phi_2$  and  $\phi_1$ , respectively, and  $\phi_2 + \phi_3 = \phi_1$ .

9.1.3 The angles  $\phi_3$ ,  $\phi_2$  and  $\phi_1$  can be calculated using:

$$\begin{aligned}\phi_1 &= \cos^{-1}[(R_1^2 + R_2^2 - R_{1+2}^2)/2R_1R_2] \\ \phi_2 &= \cos^{-1}[(R_2^2 + R_{2-1}^2 - R_1^2)/2R_2R_{2-1}] \\ \phi_3 &= \cos^{-1}[(4R_1^2 + R_{2-1}^2 - R_{1+2}^2)/4R_1R_{2-1}]\end{aligned}\quad (5)$$

If  $\phi_1 = \phi_2 + \phi_3$  within the tolerances set by the uncertainty, then proceed; otherwise check  $R$ s and  $\phi$ s.

9.1.4 Perform the same procedure as described in 9.1.3 on the second diffraction pattern with zone axis  $[u_2v_2w_2]$  (and on any others from different directions of the specimen). The basic parallelogram on the second pattern is constituted by  $R'_1$  and  $R'_2$  and the centre-spot 000. The vector  $R'_1$  shall be superimposed over the vector  $R_2$  of the pattern with zone axis  $[u_1v_1w_1]$ , i.e.  $R'_1 = R_2$  (see Figure 6). Measure the magnitude of  $R'_1$  and  $R'_2$  as well as the angle  $\beta^*$  between  $R'_1$  and  $R'_2$ . The vectors  $R_1$ ,  $R_2$  and  $R'_2$  constitute a basic cell of the reciprocal space. If the corresponding diffraction spots possess the lowest indices then the reciprocal unit cell can be obtained.

9.1.5 When a TV or CCD camera is employed, measurement and calculation on the diffraction patterns can be carried out by the computer system.

9.1.6 The angle  $\alpha^*$  between  $R_1$  and  $R'_2$  (see Figure 6) may be calculated by the following equation:

$$\cos \alpha^* = \sin \gamma^* \times \sin \beta^* \times \cos \psi^* + \cos \gamma^* \times \cos \beta^* \quad (6)$$

where

$\beta^*$  is the angle between  $R'_1$  and  $R'_2$ ,

$\gamma^*$  is the angle between  $R_1$  and  $R_2$ ,

$\psi^*$  is the angle between the diffraction pattern  $(u_1v_1w_1)^*$  and  $(u_2v_2w_2)^*$  or the zone axes  $[u_1v_1w_1]$  and  $[u_2v_2w_2]$ .

## 9.2 Indexing diffraction spots

9.2.1 Use Equation (3) to calculate the interplanar spacing  $d_{hkl}$  corresponding to the above diffraction spots. The interplanar spacing  $d_{hkl}$  can also be acquired by measuring the distance  $D_{K-hkl}$  between the Kikuchi bright and dark line pair and using Equation (4).

9.2.2 Arbitrarily index two of the spots, say  $(h_1k_1l_1)$  and  $(h_2k_2l_2)$  and then confirm from the possible indices of the other spots that:

$$h_3 = h_2 - h_1, k_3 = k_2 - k_1, l_3 = l_2 - l_1, \text{ and } h_4 = h_2 + h_1, k_4 = k_2 + k_1, l_4 = l_2 + l_1$$

Make any allowance for the multiplicity of  $\{h_1k_1l_1\}$ . If no solution is possible then recheck the determination of  $d_i$  and the angles (see 9.1.3) until one is found that satisfies these requirements within the tolerances. All spots in a continuous pattern will come from a common zone  $[uvw]$  and have a common axis lying in them. This direction is given by Equation (8). The direction  $[uvw]$  can be checked since for all  $(hkl)$ 's indexed

$$hu + kv + lw = 0 \quad (7)$$

**9.2.3** Calculate the characteristic parameters of the two-dimensional primitive cell on each reciprocal lattice plane of the crystal specimen in advance, namely the indices  $h_1k_1l_1$  and  $h_2k_2l_2$  of the primitive reciprocal vector  $g_1$  and  $g_2$ , ratio of the magnitudes  $g_2:g_1$ , the included angle between the vectors  $g_1$  and  $g_2$  and the zone axis index.

The zone axis index  $[uvw]$  can be obtained according to the following equation:

$$u:v:w = \left( \begin{array}{c|c|c} k_1 & l_1 & h_1 \\ \hline k_2 & l_2 & h_2 \end{array} \right) = [(k_1l_2 - l_1k_2) : (l_1h_2 - h_1l_2) : (h_1k_2 - k_1h_2)] \quad (8)$$

The values of  $u$ ,  $v$ ,  $w$  should be integers without a common factor. The reciprocal lattice plane characteristic parameters for cubic crystalline systems and a close-packed hexagonal system (see Annex B) usually can be obtained from the literature and handbooks. They may appear as standard patterns (References [4] and [5] in the Bibliography), or as a list in tables (Reference [3] in the Bibliography). For those specimens with a lower symmetry, reference to a diffraction database such as "The Powder Diffraction File 1997–2007", published by the International Centre for Diffraction Data (ICDD) is recommended<sup>[11]</sup>. Software is also very useful in establishing the reciprocal planes of the crystal specimen, especially in one with low symmetry structure (Reference [12] in the Bibliography).

For an unknown specimen, the chemical composition should also be determined by microanalysis (e.g. EDX analysis) and/or chemical analysis so that the specimen phase can be identified.

**9.2.4** Compare the geometrical characteristics of the experimental diffraction patterns, including the ratio  $R_2/R_1$  and  $R_{2-1}/R_1$ , the included angle between  $R_1$ ,  $R_2$  and  $R_{2-1}$ , respectively, with the calculated characteristic parameters of the primitive cell. If the experimental value is consistent with the known value within error, the diffraction spots can be indexed as  $h_1k_1l_1$ ,  $h_2k_2l_2$  and  $h_2 - h_1$ ,  $k_2 - k_1$ ,  $l_2 - l_1$ , respectively. The indices of other diffraction spots can be obtained by summation of the corresponding vectors. Therefore, the zone axis index  $[uvw]$  can be worked out.

## 10 The 180° ambiguity

The indices in a diffraction pattern with only one zone axis from a single crystal are not decided uniquely because of the 180° ambiguity created by the diffraction effect. Therefore, the spots  $h_1k_1l_1$  and  $h_2k_2l_2$  can also be indexed as  $\bar{h}_1\bar{k}_1\bar{l}_1$  and  $\bar{h}_2\bar{k}_2\bar{l}_2$ , and vice versa except that higher Laue zone diffraction spots can be obtained.

However, this ambiguity may be removed if one more pattern with a different zone axis from the same crystal can be obtained. Index the two patterns so that all the indices correspond with each other. In practice the following methods may be used.

- After recording a diffraction pattern  $[u_1v_1w_1]$ , tilt the specimen while keeping a row of spots bright, containing the central spot, until another zone axis pattern  $[u_2v_2w_2]$  appears. Record the second pattern and determine the included angle between the two patterns (see 8.2.11).
- Obtain a diffraction pattern with zone axis  $[u_1v_1w_1]$ , which is superposed on another pattern  $[u_2v_2w_2]$ .
- Tilt the specimen to get three non-parallel Kikuchi line pairs in one pattern. Unambiguous indices can be gained.

## 11 Uncertainty estimation

### 11.1 Factors affecting accuracy

The camera constant will change if the high voltage supply to the electron microscope fluctuates. Normally, stabilization ratios are  $10^5$  to 1 or better and thus this effect is minimal.

## ISO 25498:2010(E)

As discussed in Clause 4, the effective camera length is defined as follows (Reference [4] in the Bibliography):

$$L = f_o \times M_i \times M_p$$

where

$M_i$  is the magnification of the intermediate lens;

$M_p$  is the magnification of the projector lens;

$f_o$  is the focal length of the objective lens, the most sensitive factor which affects the reproducibility of  $L$ .

In turn,  $f_o$  depends on the plane of the object. The factors that control this are specimen holders of different length, support grids that are not flat, thick and buckled specimens, and the effects due to tilting the specimen.

Faulty lens settings will alter  $2L\lambda$  if the correct procedure for obtaining diffraction settings is not followed. It can be shown that

$$\frac{\Delta L}{L} = \frac{\Delta f_o}{f_o} + \frac{\Delta M_i}{M_i} + \frac{\Delta M_p}{M_p}$$

where

$\Delta L/L$  is the proportional error in the camera length  $L$ ,

$\Delta f_o/f_o$  is the proportional error in the focal length  $f_o$  of the objective lens,

$\Delta M_i/M_i$  is the proportional error in the magnification of the intermediate lens,

$\Delta M_p/M_p$  is the proportional error in the magnification of the projector lens.

In some instruments, the strength of the projector lens is fixed so that  $\Delta M_p/M_p = 0$ . However, in other instruments the projector current is variable and the accuracy of the setting has a marked effect on  $2L\lambda$ .  $\Delta M_i/M_i$  is the error in re-adjusting the intermediate lens strength to image the diffraction pattern from the back focal plane of the objective lens. This adjustment can be made with considerable accuracy, so  $\Delta M_i/M_i$  is usually very small.

### 11.2 Calibration with a reference material

Measurement of "d" spacing involves the use of a reference material so that the camera constant,  $2L\lambda$ , can be determined and the effects of variation in microscope parameters can be ignored, provided the conditions for obtaining the diffraction pattern of the standard and unknown are identical. Thus, the main errors involved in the determination of the camera constant, and consequently the  $d$  values, arise from inaccuracies in the measurement of rings and spots.

Lens aberration may lead to distortion of diffraction rings into ellipses and thus measurements of diameter shall be made at least six positions when determining the  $2L\lambda - D$  curve to determine the minimum and maximum values of the diameters (see 8.3.5). Thus, the standard deviation in the camera constant value,  $s_{cc}$ , can be determined from this calibration curve. Errors involved in the determination of the spot or ring diameters can be estimated from replicate measurements of these values and an evaluated standard deviation  $s_d$ . This uncertainty shall be combined with the calibration uncertainty associated with the measuring instrument,  $s_m$ , and thus yield an uncertainty related to spot or ring dimensions. Thus, the combined uncertainty for determination of "d" values is

$$u = \sqrt{(s_{cc})^2 + (s_d)^2 + (s_m)^2}$$

## Annex A (informative)

### Interplanar spacing of pure Au and Al

The interplanar spacing  $d_{hkl}$  of pure gold and aluminium are listed in Table A.1.

**Table A.1 — Interplanar spacing  $d_{hkl}$  of pure Au and Al**

Dimensions in nanometres

Miller indices of crystalline planes	Interplanar spacing of Au $d_{hkl}$	Interplanar spacing of Al $d_{hkl}$
{111}	0,235 50	0,233 80
{200}	0,203 90	0,202 40
{220}	0,144 20	0,143 10
{311}	0,123 00	0,122 10
{222}	0,117 74	0,116 90
{400}	0,101 96	0,101 24
{331}	0,093 58	0,092 89
{420}	0,091 20	0,090 55
{422}	0,083 25	0,082 66
{333}/{511}	0,078 00	—

NOTE 1 Lattice parameter for Au [face-centred cubic (FCC) structure, S.G: Fm3m(225)]:  $a = 0,407\ 8\ \text{nm}$ , Ref. Swanson, Tatge, Natl. Bur. Stand. (U.S.), Circ. 539,1,33 (1953).

NOTE 2 Lattice parameter for Al [FCC structure, S.G: Fm3m(225)]:  $a = 0,404\ 9\ \text{nm}$ ; Ref. Swanson, Tatge, Natl. Bur. Stand. (U.S.), Circ. 539,1,11 (1953).

ISO 25498:2010(E)

**Annex B**  
 (informative)

**Spot diffraction patterns of single crystals with body-centred cubic (BCC), face-centred cubic (FCC) and hexagonal close packed (HCP) structure<sup>1)</sup>**

**B.1 Symbols and regulation**

B.1.1 The symbol  $[uvw]$  denotes a zone axis of the diffraction pattern.

B.1.2 Regulation for the reciprocal vectors:

$R_1$  is the shortest vector in the diffraction pattern,

$R_2$  is the next shortest vector, which is not along a common line with  $R_1$ .

$R_3 = R_2 - R_1$  and  $R_3 \geq R_2 \geq R_1$

**B.2 Single-crystal diffraction patterns of BCC crystal structure ( $u^2 + v^2 + w^2 \leq 22$ )**

See Figures B.1 to B.15.

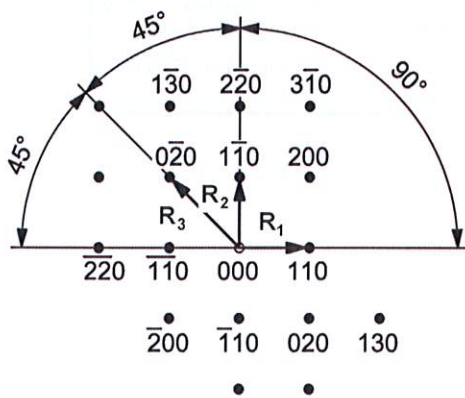

$R_2/R_1 = 1.0$   
 $R_3/R_1 = 1.414$   
 $[uvw] = [001]$

Figure B.1

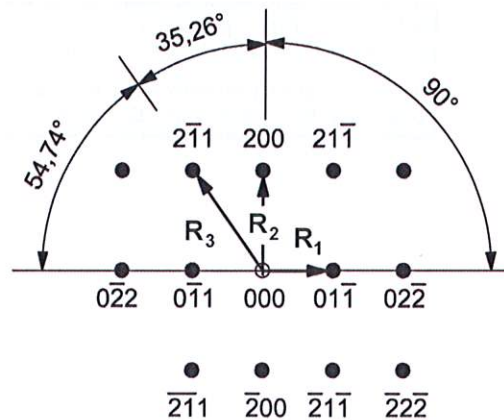

$R_2/R_1 = 1.414$   
 $R_3/R_1 = 1.732$   
 $[uvw] = [011]$

Figure B.2

1) Courtesy of ANDREWS, K.W., DYSON, D.J. and KEOWN, S.R.<sup>[4]</sup>

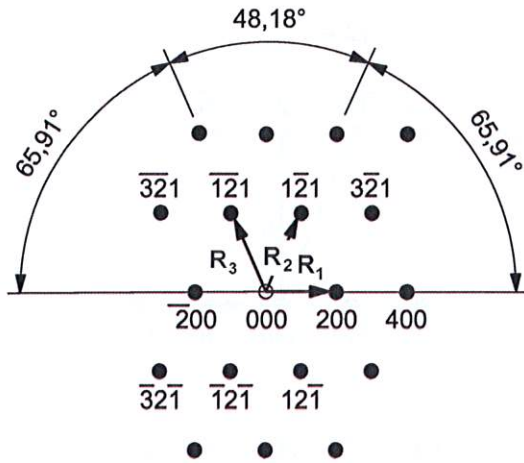

$R_2/R_1 = R_3/R_1 = 1.225$   
 $[u \ v \ w] = [012]$

Figure B.3

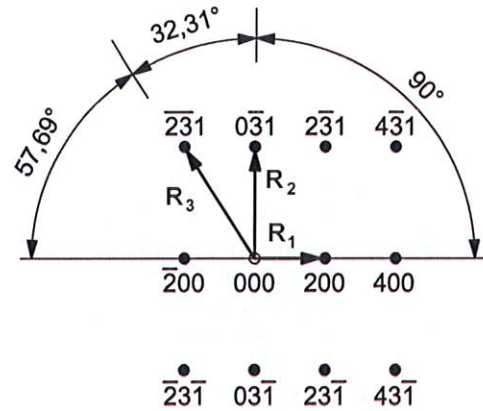

$R_2/R_1 = 1.581$   
 $R_3/R_1 = 1.871$   
 $[u \ v \ w] = [013]$

Figure B.4

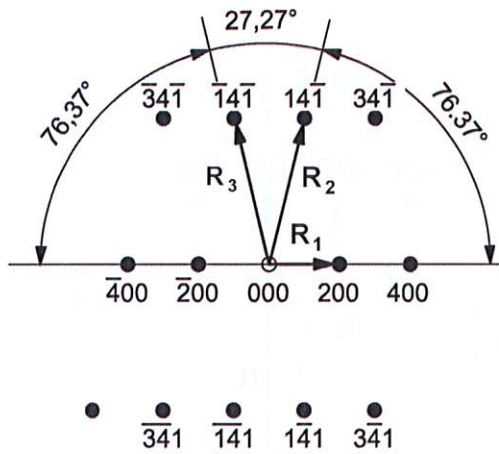

$R_2/R_1 = R_3/R_1 = 2.121$   
 $[u \ v \ w] = [014]$

Figure B.5

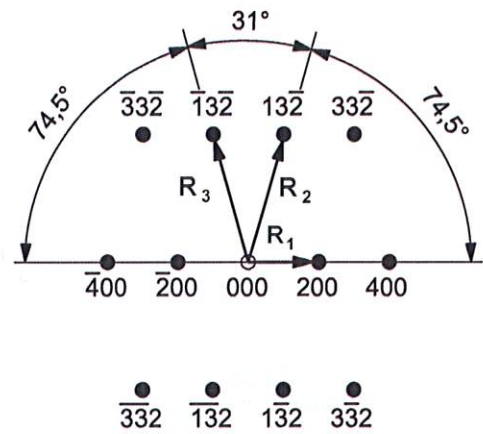

$R_2/R_1 = R_3/R_1 = 1.871$   
 $[u \ v \ w] = [023]$

Figure B.6

ISO 25498:2010(E)

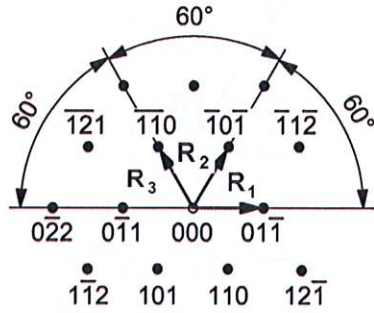

$R_2/R_1 = R_3/R_1 = 1.0$   
 $[u \ v \ w] = [\bar{1}11]$

Figure B.7

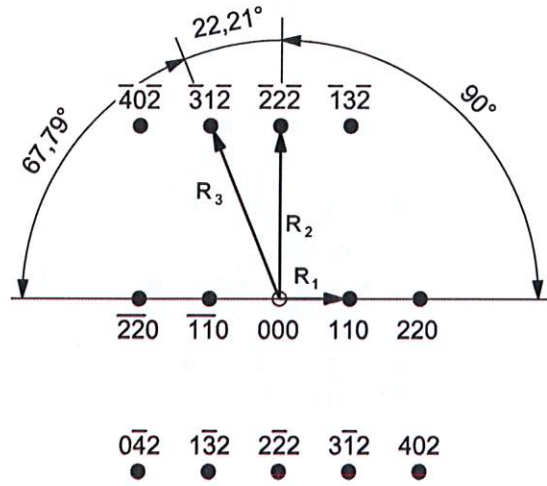

$R_2/R_1 = 2.450$   
 $R_3/R_1 = 2.646$   
 $[u \ v \ w] = [\bar{1}12]$

Figure B.8

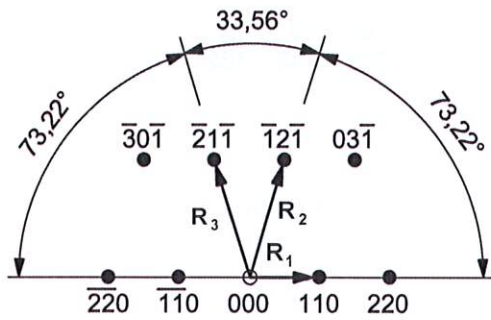

$R_2/R_1 = R_3/R_1 = 1.732$   
 $[u \ v \ w] = [\bar{1}13]$

Figure B.9

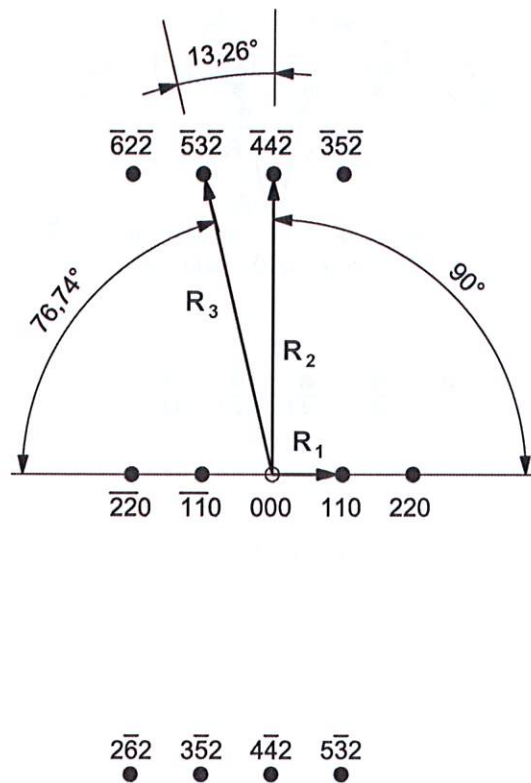

$R_2/R_1 = 4.243$   
 $R_3/R_1 = 4.359$   
 $[u \ v \ w] = [\bar{1}14]$

Figure B.10

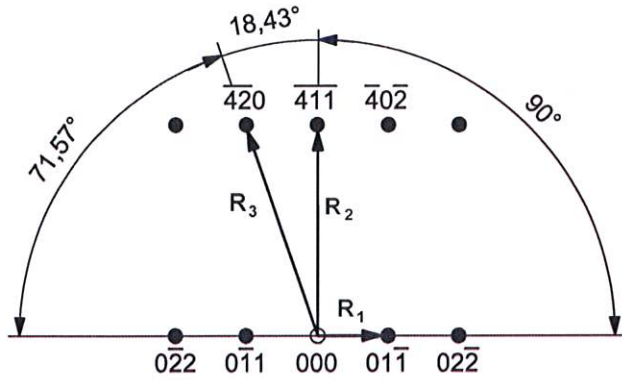

$R_2/R_1 = 3.0$   
 $R_3/R_1 = 3.162$   
 $[u \ v \ w] = [\bar{1}22]$

Figure B.11

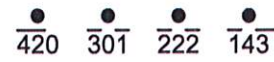
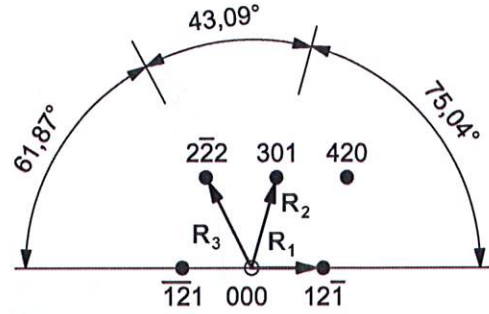

$R_2/R_1 = 1.291$   
 $R_3/R_1 = 1.826$   
 $[u \ v \ w] = [\bar{1}23]$

Figure B.12

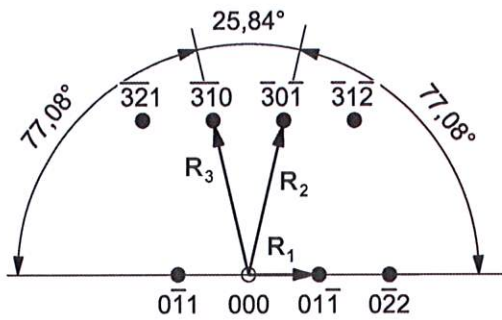

$R_2/R_1 = R_3/R_1 = 2.236$   
 $[u \ v \ w] = [\bar{1}33]$

Figure B.13

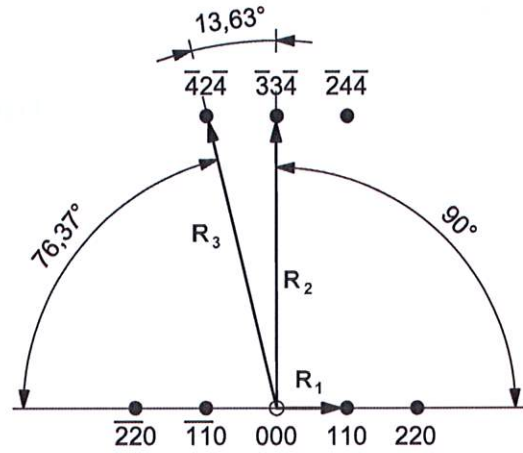

$R_2/R_1 = 4.143$   
 $R_3/R_1 = 4.243$   
 $[u \ v \ w] = [\bar{2}23]$

Figure B.14

ISO 25498:2010(E)

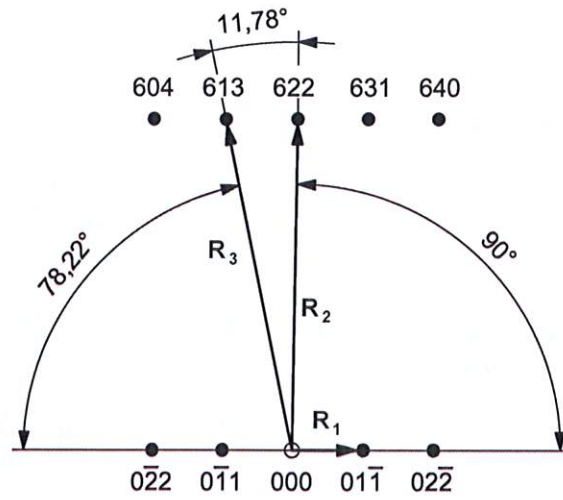

$R_2/R_1 = 4.690$   
 $R_3/R_1 = 4.796$   
 $[u \ v \ w] = [\bar{2}33]$

Figure B.15

**B.3 Single crystal diffraction patterns of FCC crystal structure ( $u^2 + v^2 + w^2 \leq 22$ )**

See Figures B.16 to B.30.

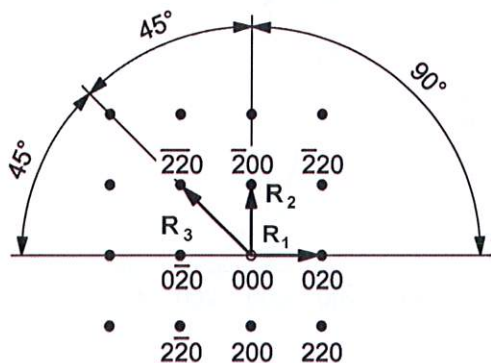

$R_2/R_1 = 1.0$   
 $R_3/R_1 = 1.414$   
 $[u \ v \ w] = [001]$

Figure B.16

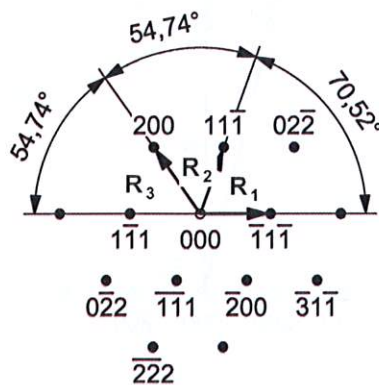

$R_2/R_1 = 1.0$   
 $R_3/R_1 = 1.155$   
 $[u \ v \ w] = [011]$

Figure B.17

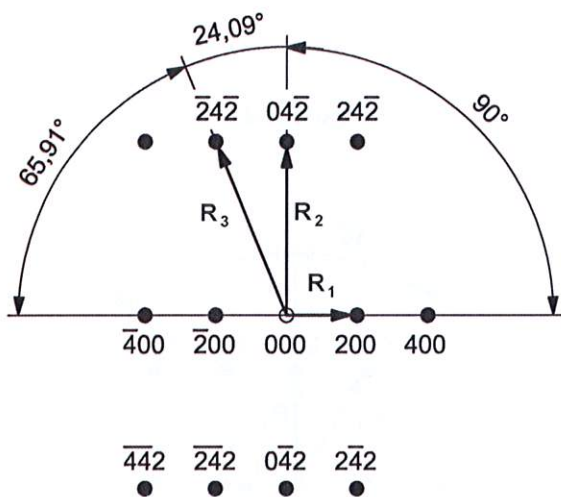

$R_2/R_1 = 2.236$   
 $R_3/R_1 = 2.450$   
 $[u \ v \ w] = [012]$

Figure B.18

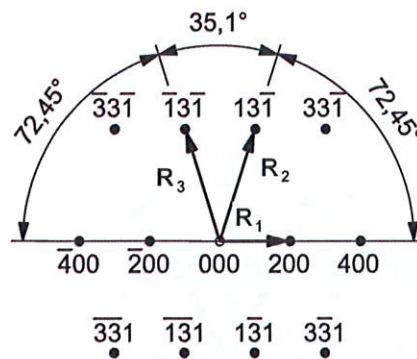

$R_2/R_1 = 1.658$   
 $R_3/R_1 = 1.658$   
 $[u \ v \ w] = [013]$

Figure B.19

ISO 25498:2010(E)

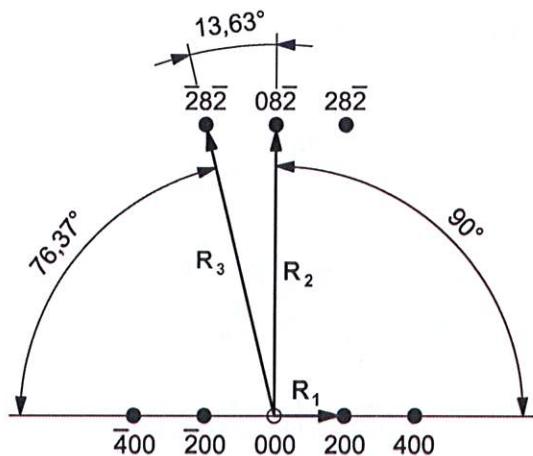

$\bar{2}82$   $0\bar{8}2$   $2\bar{8}2$

$R_2/R_1 = 4.123$   
 $R_3/R_1 = 4.243$   
 $[u \ v \ w] = [014]$

Figure B.20

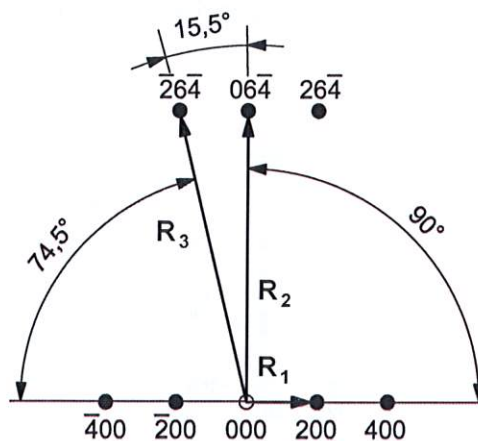

$\bar{2}64$   $0\bar{6}4$   $2\bar{6}4$

$R_2/R_1 = 3.242$   
 $R_3/R_1 = 3.606$   
 $[u \ v \ w] = [023]$

Figure B.21

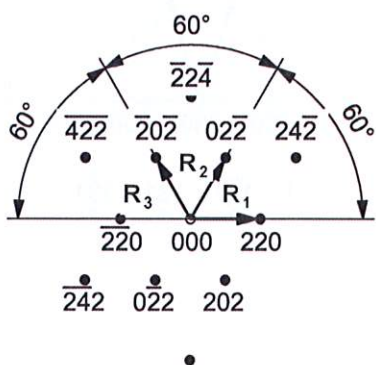

$R_2/R_1 = 1.0$   
 $R_3/R_1 = 1.0$   
 $[u \ v \ w] = [111]$

Figure B.22

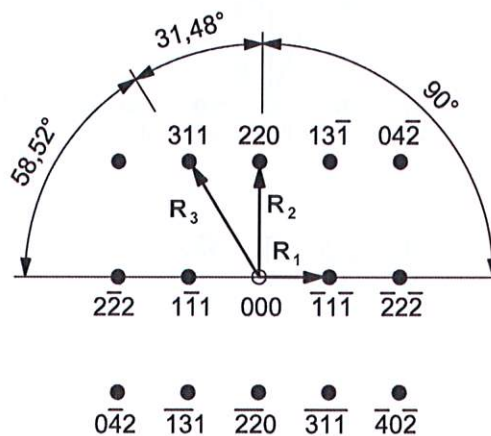

$R_2/R_1 = 1.633$   
 $R_3/R_1 = 1.915$   
 $[u \ v \ w] = [\bar{1}12]$

Figure B.23

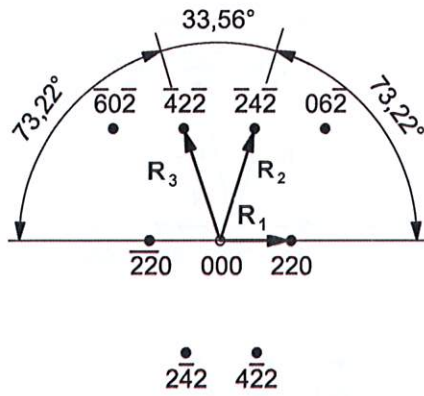

$R_2/R_1 = 1.732$   
 $R_3/R_1 = 1.732$   
 $[u \ v \ w] = [\bar{1}13]$

Figure B.24

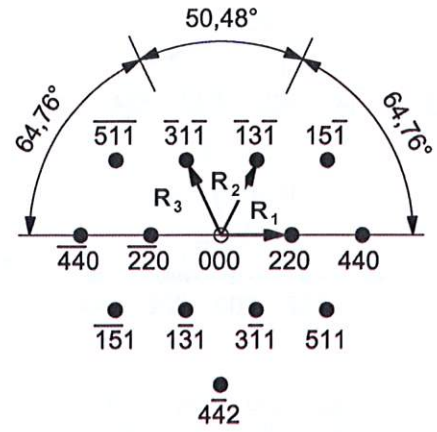

$R_2/R_1 = 1.173$   
 $R_3/R_1 = 1.173$   
 $[u \ v \ w] = [\bar{1}14]$

Figure B.25

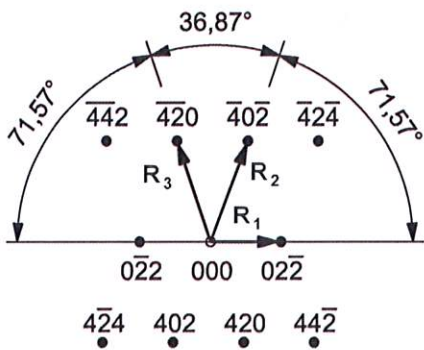

$R_2/R_1 = 1.581$   
 $R_3/R_1 = 1.581$   
 $[u \ v \ w] = [\bar{1}22]$

Figure B.26

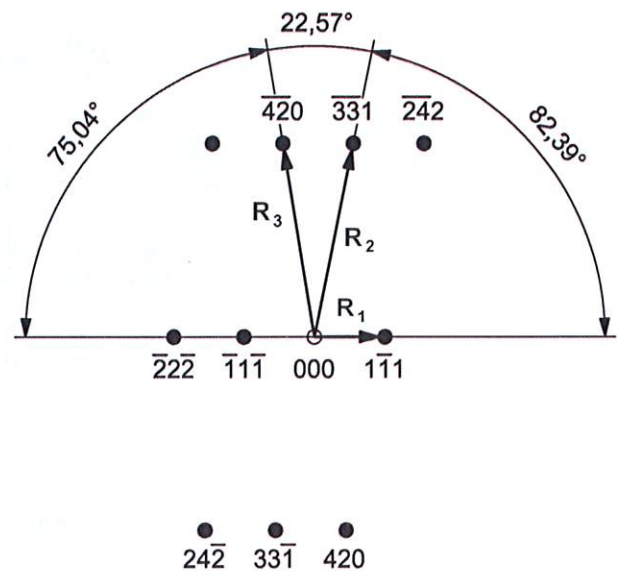

$R_2/R_1 = 2.517$   
 $R_3/R_1 = 2.828$   
 $[u \ v \ w] = [\bar{1}23]$

Figure B.27

ISO 25498:2010(E)

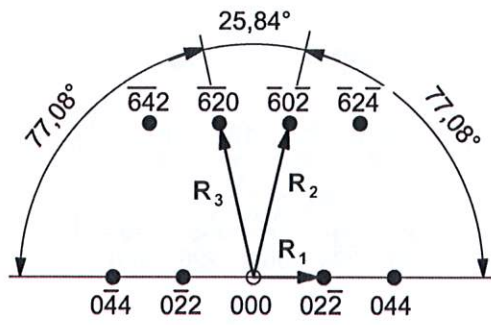

$\bar{6}24$   $\bar{6}02$   $\bar{6}20$   $\bar{6}42$

$R_2/R_1 = R_3/R_1 = 2.236$   
 $[u \ v \ w] = [\bar{1}33]$

Figure B.28

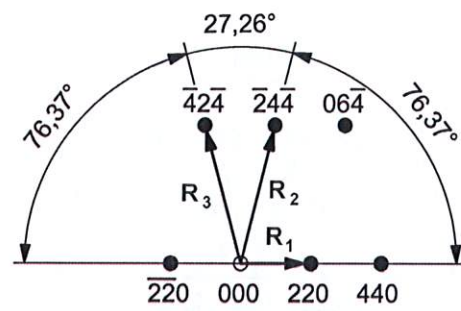

$\bar{0}64$   $\bar{2}44$   $\bar{4}24$

$R_2/R_1 = 2.121$   
 $R_3/R_1 = 2.121$   
 $[u \ v \ w] = [\bar{2}23]$

Figure B.29

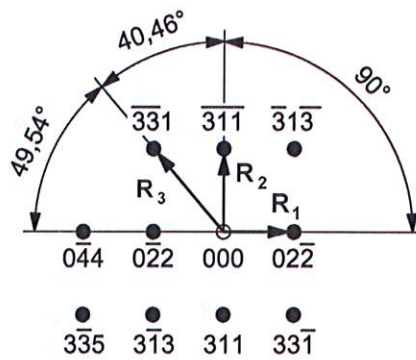

$\bar{3}35$   $\bar{3}13$   $\bar{3}11$   $\bar{3}3\bar{1}$

$R_2/R_1 = 1.173$   
 $R_3/R_1 = 1.541$   
 $[u \ v \ w] = [\bar{2}33]$

Figure B.30

**B.4 Single crystal diffraction patterns of HCP structure (for  $c/a = 1,6$ )**

See Figures B.31 to B.40.

NOTE The symbol  $\times$  denotes the forbidden diffracted spots, which can occur due to the secondary diffraction.

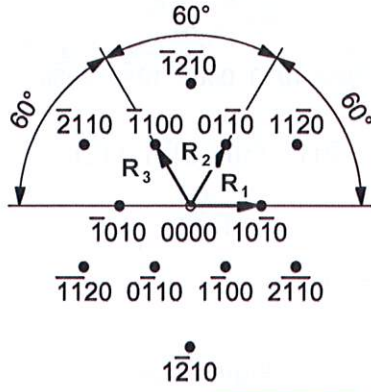

$R_3/R_1 = 1.0$   
 $R_2/R_1 = 1.0$   
 [0001]

Figure B.31

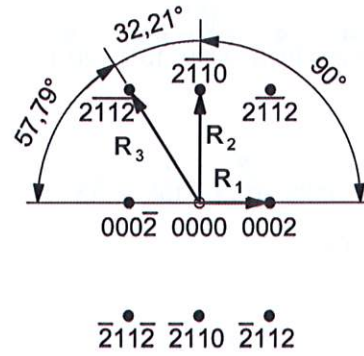

$R_2/R_1 = 1.587$   
 $R_3/R_1 = 1.876$   
 [0110]

Figure B.32

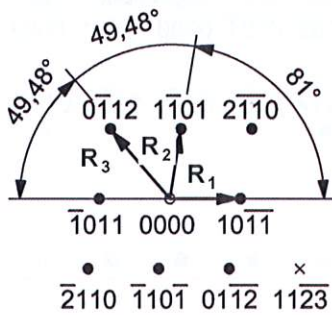

$R_3/R_1 = 1.299$   
 $R_2/R_1 = 1.0$   
 [0111]

Figure B.33

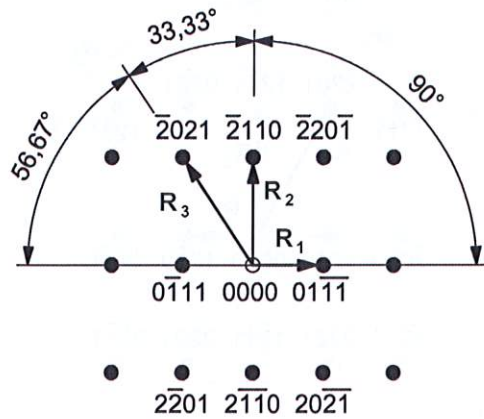

$R_2/R_1 = 1.520$   
 $R_3/R_1 = 1.820$   
 [0112]

Figure B.34

ISO 25498:2010(E)

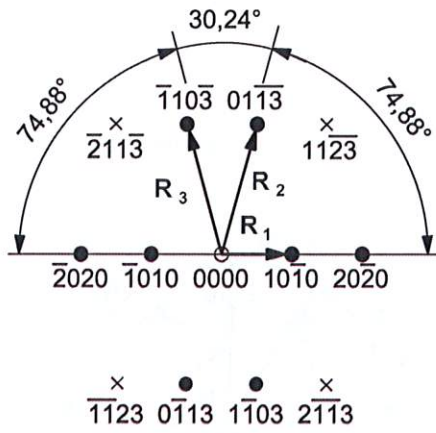

$R_2/R_1 = R_3/R_1 = 1.917$   
 $[\bar{1}\bar{2}\bar{1}1]$

Figure B.35

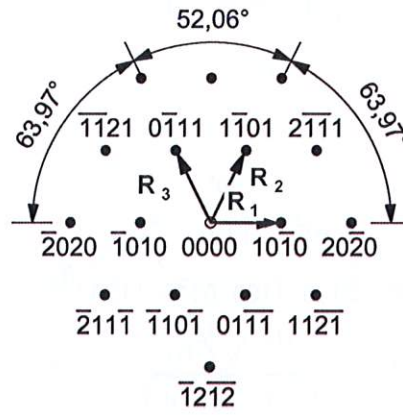

$R_2/R_1 = R_3/R_1 = 1.139$   
 $[1\bar{2}1\bar{3}]$

Figure B.36

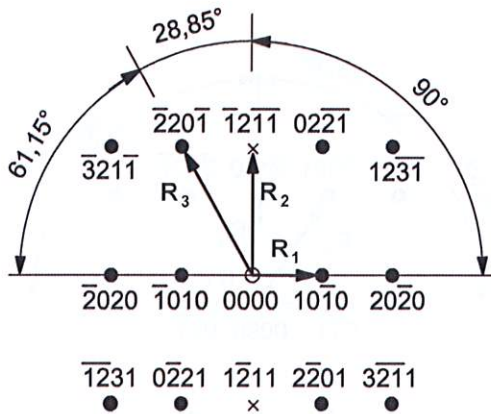

$R_2/R_1 = 1.816$   
 $R_3/R_1 = 2.073$   
 $[\bar{1}\bar{2}\bar{1}6]$

Figure B.37

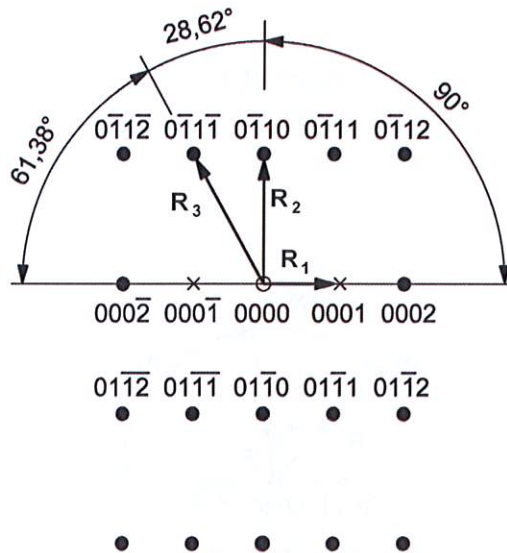

$R_2/R_1 = 1.835$   
 $R_3/R_1 = 2.088$   
 $[2\bar{1}\bar{1}0]$

Figure B.38

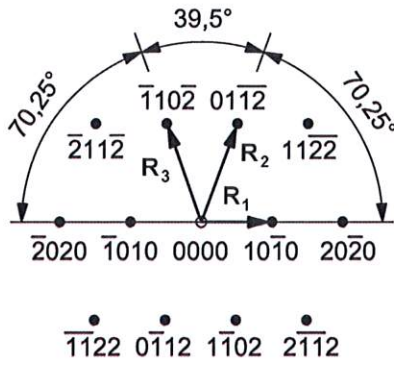

$R_2/R_1 = R_3/R_1 = 1.480$   
 $[\bar{2}4\bar{2}3]$

Figure B.39

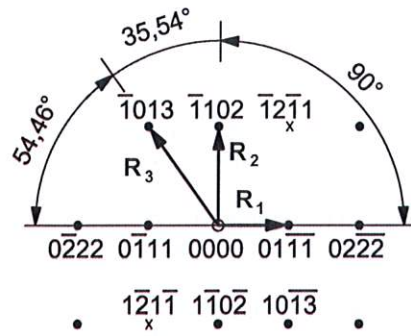

$R_2/R_1 = 1.399$   
 $R_3/R_1 = 1.720$   
 $[5\bar{1}43]$

Figure B.40

ISO 25498:2010(E)

## Bibliography

- [1] VAINSHTEIN, B.K. Structure analysis by electron diffraction, Translated and Edited by FEIGL, E. and SPINK, J.A, Pergamon Press, 1964
- [2] HIRSCH, P.B., HOWIE, A., NICHOLSON, R.B., PASHLEY, D.W. and WHELAN, M.J. Electron Microscopy of thin crystals, Butterworths, London, 1967
- [3] GUO KEXIN, YE HENGQIANG, WU YUKUN, Application of electron diffraction patterns in crystallography, Science Press, China, 1983
- [4] ANDREWS, K.W., DYSON, D.J., KEOWN, S.R. Interpretation of electron diffraction patterns, Second Edition, 1971. (Publisher Hilger, London, ISBN-0-85274-170-7)
- [5] EDINGTON, J.W. Practical Electron Microscopy in Materials Science, Vol. II, Electron Diffraction in The Electron Microscope, Macmillan & Co Ltd, London, 1975
- [6] THOMAS, G. and GORINGE, M.J. Transmission Electron Microscopy of Materials, Wiley-Interscience, New York 1979
- [7] AMELINCKX, A., GEVERS, R., VAN LANDUYT, J. Diffraction and Imaging Techniques in Material Science, Second edition, North-Holland Publishing Company, 1978
- [8] FULTZ, B, HOWE, J. Transmission Electron Microscopy and Diffractometry of Materials, Springer-Verlag, Berlin Heidelberg 2001
- [9] ASTM E 3-2001, Standard practice for preparation of metallographic specimens
- [10] GOODHEW, P.J. Specimen preparation for transmission electron microscopy of materials, Oxford University Press, Royal Microscopical Society, 1984
- [11] The Powder Diffraction File 1997–2007, JCPDS, International Centre for Diffraction Data (ICDD)
- [12] WILLIAMS, D.B. and CARTER, C.B. Transmission Electron Microscopy: A Textbook for Materials Science, Plenum Press, New York 1996

**ISO 25498:2010(E)**

---

---

**ICS 71.040.50**

Price based on 28 pages

